

BuchtaL CASA

Eleganza e praticità: il calore naturale delle argille cotte per qualificare l'abitare quotidiano.

- Valenze:
- igiene e facilità di pulizia
 - inalterabilità del colore nel tempo
 - antiscivolosità e sicurezza
 - un unico materiale per fondi e pezzi speciali



Dimensioni nominali (in cm)	12,5x25	25x25	15x15	15x30	6,2x25	8,3x25	25x30	25x30	12,5x25
Immagine									
					Listello	Listello	Gradino con scanalature	Gradino scan. ang. dx/sx	Fiorentino piccolo

GOLDLINE									
851	•	•	•	•		•			•
852	•	•	•	•		•			•
853	•	•	•	•		•			•
854	•	•	•	•		•			•
855	•	•	•	•		•			•
856	•	•	•	•		•			•

CERAMICA NATURALE									
010S	•	•				•	•		
070S	•	•				•	•		
948	•	•				•	•		
950	•	•							
958	•	•							

ETRUSCA									
9010F	•	•		•					•
9011F *	•	•		•					•
9015	•	•		•					•
9012 *	•	•		•					•

COTTO NATURALE									
43434	•	•		•					

HISTORIA									
951	•	•			•	•			

LEGENDA: • = di serie • = a richiesta

25x35	19,4x44x10,8	35x35	12,5x25	12,5x30	25x30	8,3x25	8,3x30	8,3x25	Dimensioni nominali (in cm)
									Immagine
Gradino fiorentino	Scamillo fiorentino dx/sx	Angolare dx/sx	Elemento a L 25	Elemento a L 30	Residenze	Zoccolo arrotondato 25	Zoccolo arrotondato 30	Angolare orizzontale	

GOLDLINE									
•	•	•		•		•	•	•	851
•	•	•		•		•	•	•	852
•	•	•		•		•	•	•	853
•	•	•		•		•	•	•	854
•	•	•		•		•	•	•	855
•	•	•		•		•	•	•	856

CERAMICA NATURALE									
•	•	•	•	•		•			010S
•	•	•	•	•		•			070S
•	•	•	•	•		•			948
•	•	•	•	•		•			950
•	•	•	•	•		•			958

ETRUSCA									
			•	•		•	•		9010F
			•	•		•	•		9011F
			•	•		•	•		9015
			•	•		•	•		9012

COTTO NATURALE									
•	•	•	•	•		•	•		43434

HISTORIA									
			•			•			951

LEGENDA: • = di serie • = a richiesta



ETRUSCA

Piastrelle pavimento e parete



piastrella cm 15x30



piastrella cm 12,5x25

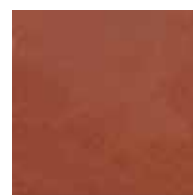

piastrella cm 25x25

Pezzi speciali



fiorentino piccolo cm 12,5x25



elemento a L cm 12,5x30



zoccolo arrotondato cm 8,3x30



elemento a L cm 12,5x25



zoccolo arrotondato cm 8,3x25

COLORI
FONDI E PEZZI SPECIALI



9010F - Rubra



9011F - Rosso terra

* Produzione speciale solo a richiesta per quantità minima.



9015 - Papiro



9012 - Sabbia





* Produzione speciale solo a richiesta per quantità minima.



FORMATI

FONDI - RIVESTIMENTO PER PAVIMENTO E PARETE

Piastrelle ceram. estruse, norma DIN EN 14411, gruppo All_g - parte 1, smaltate-vevtrinate (SM) per pavimenti e pareti in interni ed esterni (klinker).

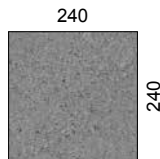
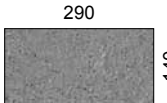
Dimensioni nominali (in cm)	12,5x25	25x25	15x30
Spessore			
Immagine quotata (in mm)			

Formato	1010	1630	1020
Dimensioni reali (in mm)	115x240x10	240x240x10	140x290x11
Gruppo d'impiego	3	3	3

Sicurezza antiscivolo		R10	R10	R10
Codice articolo	9010F	9010F - 1010	9010F - 1630	9010F - 1020
Codice prezzo/m ²		M01	M10	M10

Sicurezza Antiscivolo		R10	R10	R10
Codice articolo	9011F	9011F - 1010	9011F - 1630	9011F - 1020
Codice prezzo/m ²		A RICHIESTA	A RICHIESTA	A RICHIESTA

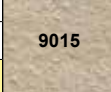
Sicurezza Antiscivolo		R10	R10	R10
Codice articolo	9015	9015 - 1010	9015 - 1630	9015 - 1020
Codice prezzo/m ²		M01	M10	A RICHIESTA

Sicurezza Antiscivolo		R10	R10	R10
Codice articolo	9012	9012 - 1010	9012 - 1630	9012 - 1020
Codice prezzo/m ²		A RICHIESTA	A RICHIESTA	A RICHIESTA

Pezzi/m ²	33	16	22,22
Kg/m ²	19,80	20,16	20,33
Pacco/pz	26 = 0,788 m ²	13 = 0,813 m ²	18 = 0,810 m ²
Pacco/Kg	15,60	16,38	16,47
Pallet/m ²	56,727	51,188	37,264
Pallet/Kg	1.123,25	1.031,99	757,62

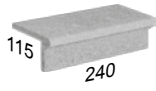
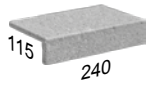
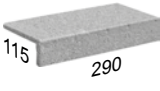

FORMATI PEZZI SPECIALI

Dimensioni nominali (in cm)	12,5x25	12,5x25	12,5x30
Immagine quotata (in mm)	 Fiorentino piccolo	 Elemento a L 25	 Elemento a L 30

Formato	9822	4822	4825
Dimensioni reali (in mm)	115/52x240x11	115/52x240x11	115/52x290x11
Gruppo d'impiego	-	-	-

Sicurezza antiscivolo		R10	R10	R10
Codice articolo	9010F	9010F - 9822	9010F - 4822	9010F - 4825
Codice prezzo/pz		U66	U62	U67

Sicurezza Antiscivolo		R10	R10	R10
Codice articolo	9011F	9011F - 9822	9011F - 4822	9011F - 4825
Codice prezzo/pz		A RICHIESTA	A RICHIESTA	A RICHIESTA

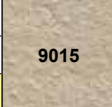
Sicurezza Antiscivolo		R10	R10	R10
Codice articolo	9015	9015 - 9822	9015 - 4822	9015 - 4825
Codice prezzo/pz		A RICHIESTA	U62	A RICHIESTA

Sicurezza Antiscivolo		R10	R10	R10
Codice articolo	9012	9012 - 9822	9012 - 4822	9012 - 4825
Codice prezzo/pz		A RICHIESTA	A RICHIESTA	A RICHIESTA

Pezzi/m ² - ml	4/ml	4/ml	3,33/ml
Kg/pz - ml	3,88/ml	3,88/ml	3,9/ml
Pacco/pz - ml	8 = 2 ml	8 = 2 ml	8 = 2,4 ml
Pacco/Kg	7,8	7,76	9,36
Pallet/pz	728	728	320
Pallet/Kg	709,80	706,16	374,72

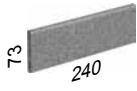
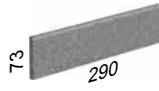

FORMATI PEZZI SPECIALI

Dimensioni nominali (in cm)	8,3x25	8,3x30
Immagine quotata (in mm)	 Zoccolo arrotondato 25	 Zoccolo arrotondato 30

Formato	9066	9063
Dimensioni reali (in mm)	73x240x11	73x290x11
Gruppo d'impiego	-	-

Sicurezza antiscivolo		-	-
Codice articolo	9010F	9010F - 9066	9010F - 9063
Codice prezzo/pz		U54	U55

Sicurezza Antiscivolo		-	-
Codice articolo	9011F	9011F - 9066	9011F - 9063
Codice prezzo/pz		A RICHIESTA	A RICHIESTA

Sicurezza Antiscivolo		-	-
Codice articolo	9015	9015 - 9066	9015 - 9063
Codice prezzo/pz		U54	A RICHIESTA

Sicurezza Antiscivolo		-	-
Codice articolo	9012	9012 - 9066	9012 - 9063
Codice prezzo/pz		A RICHIESTA	A RICHIESTA

Pezzi/ml	4/ml	3,33/ml
Kg/pz - ml	1,6/ml	1,6/ml
Pacco/pz - ml	22 = 5,5 ml	22 = 6,6 ml
Pacco/Kg	8,8	10,56
Pallet/pz	2.860	2.112
Pallet/Kg	1.144	1.013,76

